

## Works Like AutoCAD! But Offers Greater Innovative Advancement!

DoubleCAD XT Pro v3 is the advanced version of DoubleCAD XT. It is a professional 2.5D CAD application that provides all the power required to get projects done on time, at a fraction of the cost of AutoCAD LT, yet is fully .DWG compatible and packed with more innovative features.

Switching from or using in conjunction with an AutoCAD seat product means you can set a new standard of industry excellence, whilst driving further ROI for yourself as a result of increased productivity.

### Why choose DoubleCAD XT Pro?

- ✓ **Industry Familiarity!** Feels and works like AutoCAD, but offers further advancement to increase productivity efficiently and effectively.
- ✓ **Innovation that Breaks the Mould!** Answers the prayers of those looking for a more dynamic 2D CAD program, that breaks free from industry stagnation, offers greater innovation and all at a competitive price.
- ✓ **Minimal Switching Costs!** DoubleCAD XT Pro can read and write nearly 30 file formats and has incredible .dwg support; meaning you can protect and remain profitable with existing drawings.
- ✓ **Echos the Voice of Industry Professionals!** DoubleCAD XT Pro has been developed in response to comments accumulated from the industry professionals: **designers and drafters**.
- ✓ **Affordable Excellence!** Innovative features, yet a familiar user interface; all for a very competitive industry price. You won't find a more cost effective product on the market that exceeds industry standards.

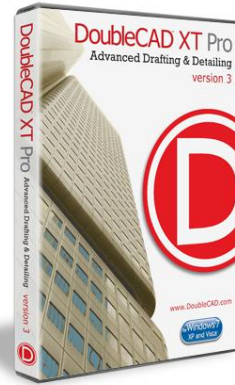

RRP: £425.00

Contact your reseller for multiple-user licence pricing.



Developed by IMSI

Works with  
**Windows® 7**

#### Minimum System Requirements:

Pentium® IV Processor; Microsoft® Windows® XP with 512 MB RAM; Windows Vista or Windows 7 with 1024 MB RAM; 300 MB of free hard disk space; 64+ MB of swap space; Super VGA (1024 x 768) display; High Color (16 bit) graphics support; 4X DVD-ROM drive.

For further information and pricing, please contact your reseller.

Tel: 01480 400000, Fax: 01480 400200



## DoubleCAD Pro v3 Key Features

### Architectural Tools

DoubleCAD XT Pro includes an integrated suite of architectural tools that accelerate productivity in 2D design and drafting, or in the documentation of existing compatible 3D architectural models. The DoubleCAD AEC objects are AutoCAD® Architecture (ACA) compatible so that .DWG models with ACA extensions may be read, modified, and documented as needed.

**New for v3:** The architectural objects have full 3D capabilities so that elevations, floorplans, and ISO views are easier to document. There are also many other improvements to the tools, including many more door and window types and shapes, terrain capabilities, and more.

### Drawing Compare

**New for v3:** DoubleCAD Drawing Compare application installs a menu item so that it can be launched directly from within the Tools menu of DoubleCAD. Select two drawings, whether .2CD, DWG, or .BMP images, and Drawing Compare will perform a visual comparison of the two.

### Parametric Constraints

**Parametric Drawing:** For precision and productivity this tool is invaluable. Allowing you greater control to enforce design intent, and may very quickly modify a design by using geometric and dimensional constraints. The variable palette allows you to set values to driving dimensions, including formulaic relationships between objects.

**Proven Technology:** This feature includes the D-Cubed™ 2D Dimensional Constraint Manager (2D DCM) from Siemens PLM Software — This is the same trusted engine used by far more expensive design platforms such as AutoCAD® 2010, Autodesk Inventor®; by Dassault Systems for CATIA and SolidWorks®; by Siemens Industry Software Limited for Solid Edge; and by think3® for thinkdesign.

### File Interoperability

Invaluably supports dozens of file formats making it an ideal drawing and drafting companion to a broad spectrum of applications. Open, import, or embed up to 35 file formats and export up to 28, including. DWG, DXF, SKP (Google™ SketchUp™), .3DM (Rhinoceros®), .3DS (Autodesk® 3ds Max®), IGES, STEP, .OBJ, COLLADA (.DAE); vector formats include .EPS and .SVG; raster formats include .BMP, .GIF, .JPG, .PNG, .TIF, and more. DoubleCAD reads and writes .DWG and .DXF files from R14 through 2009 (2010 coming soon) including AutoCAD® Architecture extensions.

## Architectural Tools

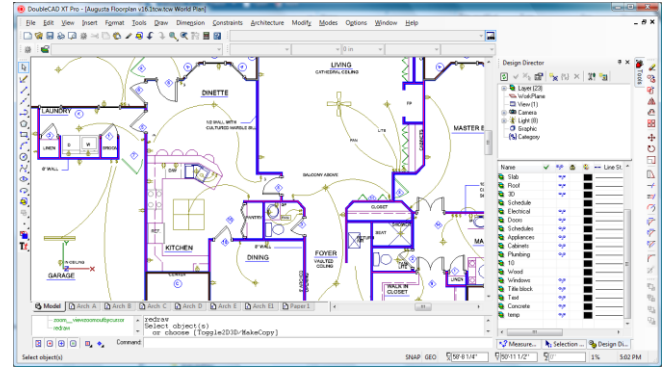

## Drawing Compare

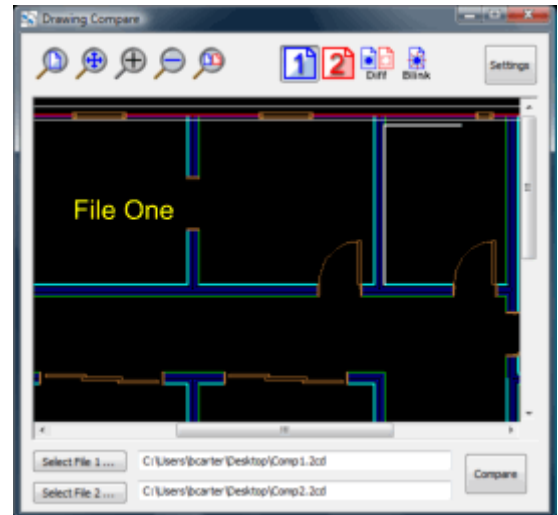

## Parametric Drawing

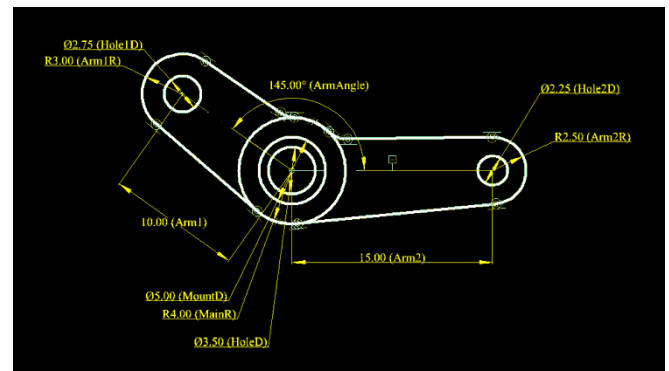



## DoubleCAD Pro v3 Further Key Features

- **DWG 2010/2011 Support!**
- **2D Drafting & Detailing** – DoubleCAD XT Pro excels in its 2D capabilities. The ability to explode viewpoints makes it easy to create flat 2D vector drawings from any view of the model.
- **Parametric Parts Manager** – Create reusable 2D and 3D parts that are parametrically defined. Assigned parameters become a part of the object's properties
- **Hatch Pattern Creator** – Allows you to easily create, modify, and combine hatch patterns with control over scaling, orientation and position. Combined with automatic detection of repeating patterns, making new hatch patterns is now quick and easy.
- **Object Snap Prioritisation** - Customise relative prioritisation of snaps, minimising tedious manual control
- **Style Manager** – Allows for complete design control of the style of each of the components of your architectural drawing; including dimensions, text and all architectural object types
- **Transparent & Bitmap Fills** – Create custom gradient fills, hatch patterns, and bitmap fills. Layering transparent fills is unique and dramatically improves presentation of design intent
- **Brush Style Editor** – Brush Style Editor for combining, layering, and creating new gradient and bitmap fills types (even hatch patterns)

▪ **Enhanced Format Painter** - DoubleCAD's enhanced Format Painter matches more than 2x as many object properties as AutoCAD's Match Properties

▪ **Bezier Curves** – Create and edit Bezier curves easily. Using weighted Bezier handles, it is simple to create Beziers with smooth and cusped nodes for more realistic organic curves

▪ **Software Developers Kit** – Supports the development of new tools, functions, and behaviours for use in DoubleCAD XT Pro. Specialised tools for vertical applications can be created and added, Even commercial plug-in applications may be developed and sold.

and many more.....

## 2D Drafting & Detailing

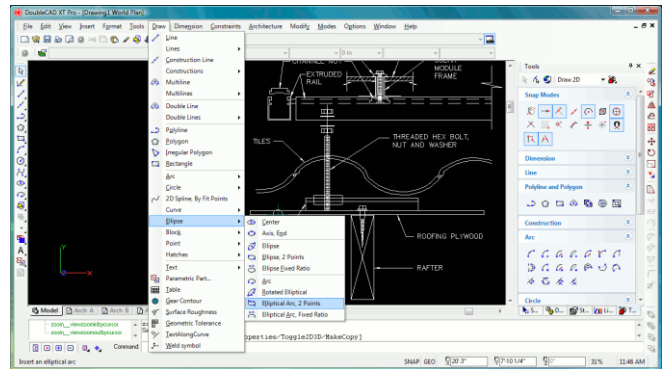

## Object Snap Prioritisation

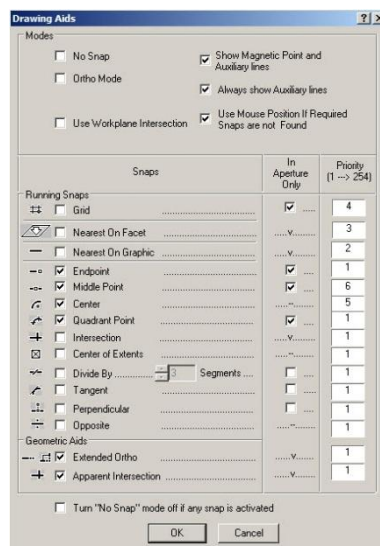

## Parametric Parts Manager

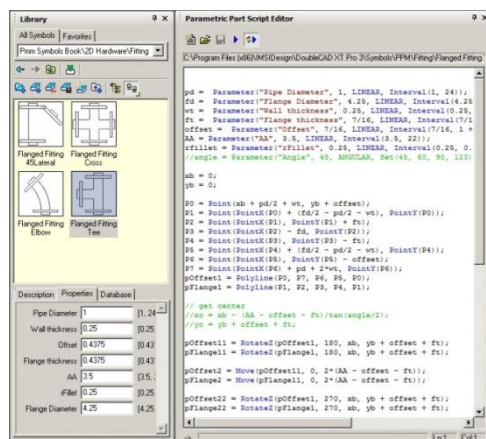

## New Powerful Special Features for Pro v3

In response to top customer requests the Pro v3 version of DoubleCAD XT has been developed to focus on three main areas to drive productivity excellence:

1. Performance
2. Interoperability
3. Customisation

### Performance

Enjoy hyper – accelerated graphic performance. Increase zoom and pan navigation up to 60x faster. Smooth 2D graphics performance is especially noticeable with larger drawing files . With Redsdk GPU acceleration technology, there's no waiting, no hesitation and no loss of concentration. **Genius!**

### Interoperability

Share and receive CAD files with others easily and efficiently boosting performance! DoubleCAD XT Pro v3 has extensive interoperability that supports the latest industry file formats including AutoCAD, DWG 2010/2011, SketchUp v8, SKP, Rhino, 3DM, DoubleCAD, 2CD and many more. Enjoy unmatched interoperability with many industry standard design applications. Free yourself to use the best tools to get your job done regardless of attempted monopolies or pigeon – holed design solutions.

**Open .SKP (Google™ SketchUp™ to v8):** DoubleCAD imports all visible geometry, layers, and components, converts all components to DoubleCAB blocks to optimise drawing performance and creates a paperspace from each SketchUp™ scene.

Interoperability means you can maintain your intellectual property investment supporting older file, models and parts.

**New for v3! Batch File Convertor:** An intelligent tool that allows you to select files of one type and convert them to any of the file formats DoubleCAD supports for saving.

### Customisation

Cut down time on repetitive heavy CAD drafting and detailing related tasks! Use DoubleCAD XT Pro uses 'Ruby Scripting' to create customised scripts and commands to help automate tasks and functions so that you can work more efficiently. DoubleCAD XT Pro is based on the same Ruby programming language as Google SketchUp, so if you are used to writing Ruby scripts for SketchUp, writing Ruby scripts for DoubleCAD XT Pro will be just as natural.

## Interoperability

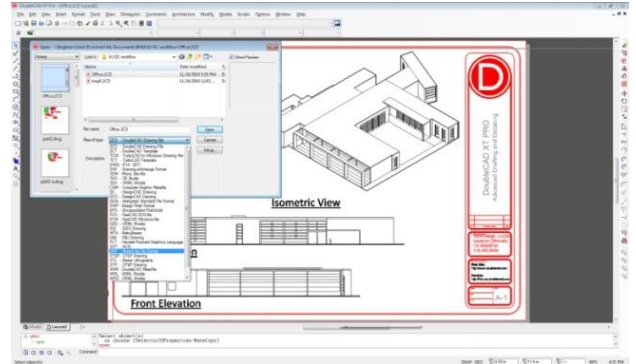

## Incredible User Benefits

### **Increased ROI (Return on Investment)!**

DoubleCAD XT Pro is designed to offer a familiar environment to AutoCAD, allowing you to get accustomed to the program quickly and ensure you benefit immediately from the unique DoubleCAD XT Pro innovative features. **Quicker advancement!**  
**Quicker return on ROI!**

**Competitive Price!** Incredible features that exceed current industry standard in productivity, all offered at a very competitive price compared to the market leaders.

**Speed up Efficiency !** Designed to help you speed up efficiency, whilst driving you to exceed current performance industry standards with smart new innovative features.

**Competitive Advantage !** Powerful features that speed up performance giving you competitive advantage.

**Streamlines Workflows!** DoubleCAD XT Pro can be used as a stand alone product or to compliment an AutoCAD seat product ; either way it promises to help you manage a seamless workflow.

**New Powerful Features + Familiar User Interface = Increased Productivity & Quicker Return on ROI.**